

1. Description

The KNE4603A2 is the high cell density trenched Dual N-channel MOSFET, which provide excellent RDSON and gate charge for most of the synchronous buck converter applications. The KNE4603A2 meet the RoHs and Green Product requirement.

2. Features

- n $R_{DS(on)}=16m\Omega(\text{typ})@ V_{GS}=10\text{ V}$
- n Super low gate charge
- n Green device available
- n Excellent Cdv/dt effect decline
- n Advanced high cell density trench technology

3. Pin configuration

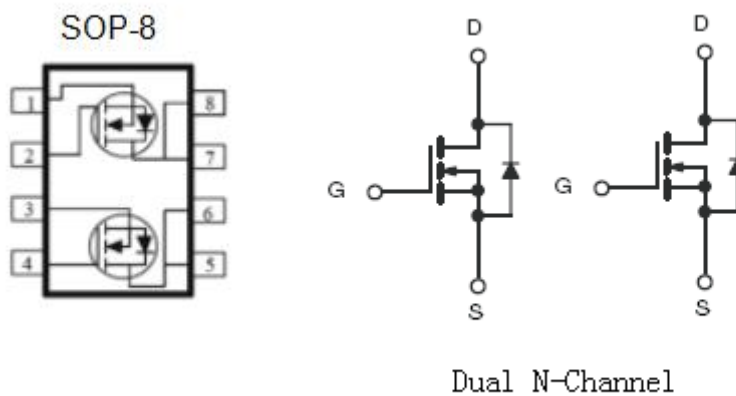

Pin	Function
1,3	Source
2,4	Gate
5,6,7,8	Drain

4. Ordering Information

Part Number	Package	Brand
KNE4603A2	SOP8	KIA

5. Absolute maximum ratings

(T_A=25°C, unless otherwise noted)

Parameter	Symbol	Rating	Units	
Drain-source voltage	V _{DSS}	30	V	
Gate-source voltage	V _{GS}	±20	V	
Continuous drain current	T _A =25°C	I _D	9	A
	T _A =70°C	I _D	7.2	A
Pulsed drain current ¹⁾	I _{DM}	36	A	
Total power dissipation	T _A =25°C	P _D	2.1	W
	T _A =70°C	P _D	1.7	W
Junction and storage temperature range	T _J , T _{STG}	-55 to 150	°C	
Thermal resistance-junction to ambient	R _{θJA}	60	°C/W	

5. Electrical characteristics

(T_J=25°C, unless otherwise noted)

Parameter	Symbol	Condition	Min	Typ	Max	Unit
Drain-Source Breakdown Voltage	V _{(BR)DSS}	V _{GS} =0V I _D =250μA	30	--	--	V
Zero Gate Voltage Drain Current	I _{DSS}	V _{DS} =30V, V _{GS} =0V, T _A =25°C	--	--	1	μA
		V _{DS} =24V, V _{GS} =0V, T _A =125°C	--	--	100	uA
Gate-Body Leakage Current	I _{GSS}	V _{GS} =±20V, V _{DS} =0V	--	--	±100	nA
Gate Threshold Voltage	V _{GS(TH)}	V _{DS} =V _{GS} , I _D =250μA	1	1.6	2.5	V
Drain-Source On-State Resistance ²⁾	R _{DS(ON)}	V _{GS} =10V, I _D =6A	--	16	24	mΩ
		V _{GS} =4.5V, I _D =4A	--	24	30	mΩ
Input Capacitance	C _{iss}	V _{DS} =15V, V _{GS} =0V, f=1MHz	--	480	--	pF
Output Capacitance	C _{oss}		--	70	--	pF
Reverse Transfer Capacitance	C _{rss}		--	59	--	pF
Total Gate Charge	Q _g	V _{DS} =15V I _D =4A, V _{GS} =4.5V	--	4.9	--	nC
Gate Source Charge	Q _{gs}		--	1.1	--	nC
Gate Drain Charge	Q _{gd}		--	2	--	nC
Turnon Delay Time	t _{d(on)}	V _{DD} =15V, I _D =1A, R _G =3.3Ω, V _{GS} =4.5V	--	3.1	--	ns
Turnon Rise Time	t _r		--	8.6	--	ns
TurnOff Delay Time	t _{d(off)}		-	18	--	ns
TurnOff Fall Time	t _f		--	5.0	--	ns
Source drain current(Body Diode)	I _{SD}	T _A =25°C	--	--	3	A
Forward on voltage ²⁾	V _{SD}	T _j =25°C, I _{SD} =4A, V _{GS} =0V	--	0.81	1.2	V

Notes:

1. Pulse width limited by maximum allowable junction temperature
2. Pulse test ; Pulse width≤300us, duty cycle≤2%.

6. Test circuits and waveforms

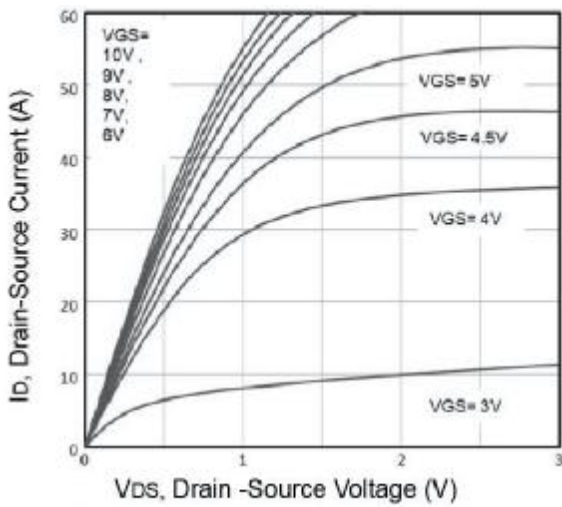

Fig1. Typical Output Characteristics

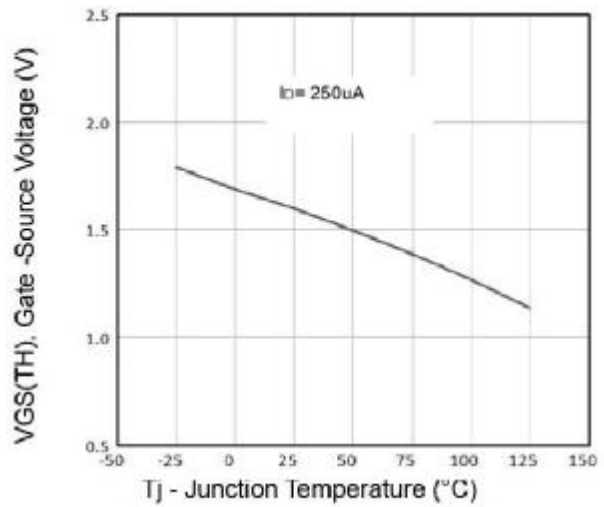

Fig2. VGS(TH) Voltage Vs. Temperature

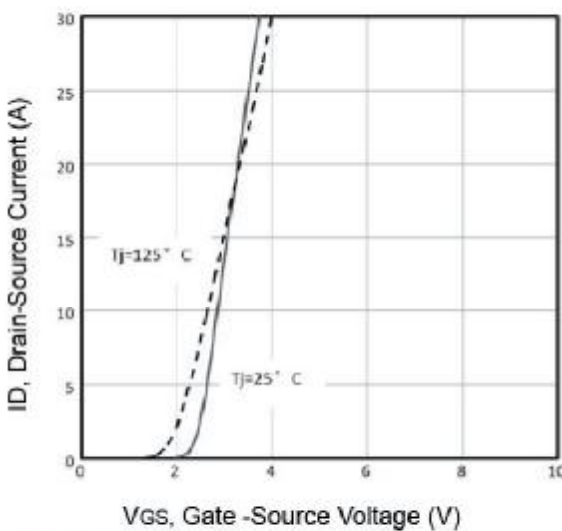

Fig3. Typical Transfer Characteristics

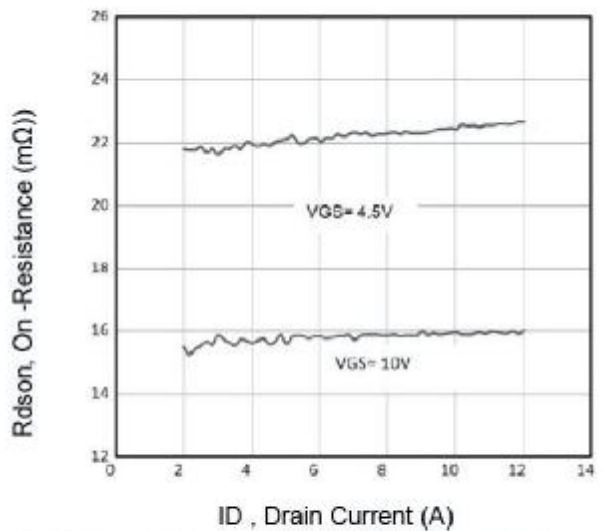

Fig4. On-Resistance vs. Drain Current and Gate

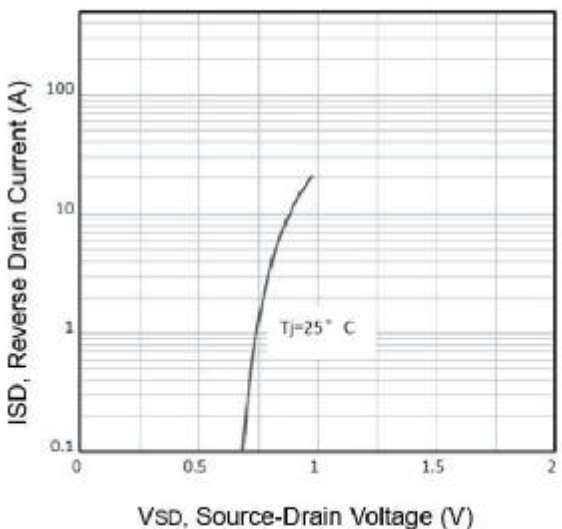

Fig5. Typical Source-Drain Diode Forward Voltage

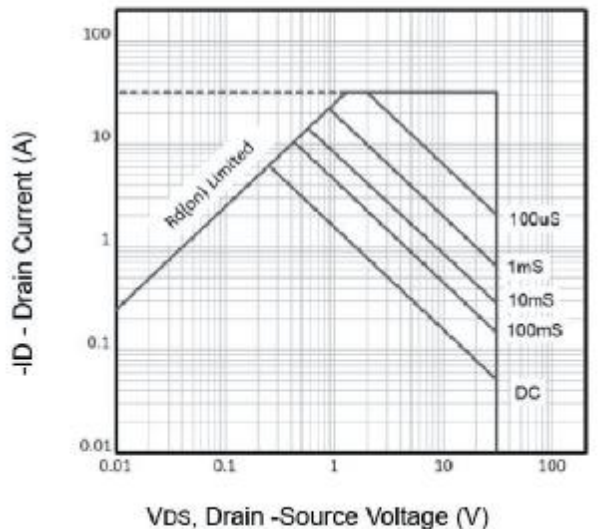

Fig6. Maximum Safe Operating Area

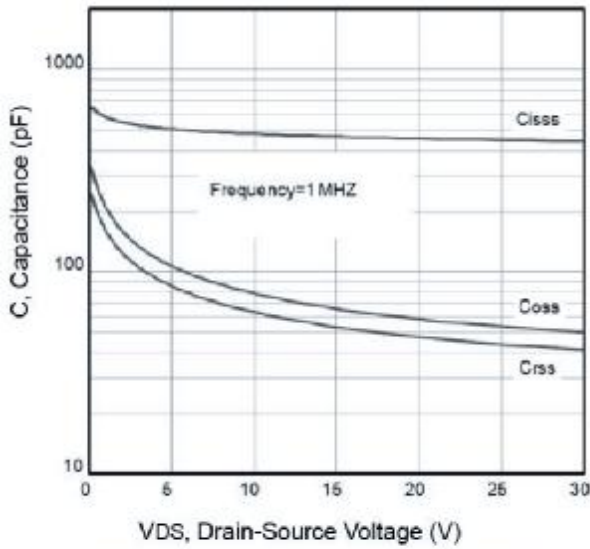

Fig7. Typical Capacitance Vs. Drain-Source Voltage

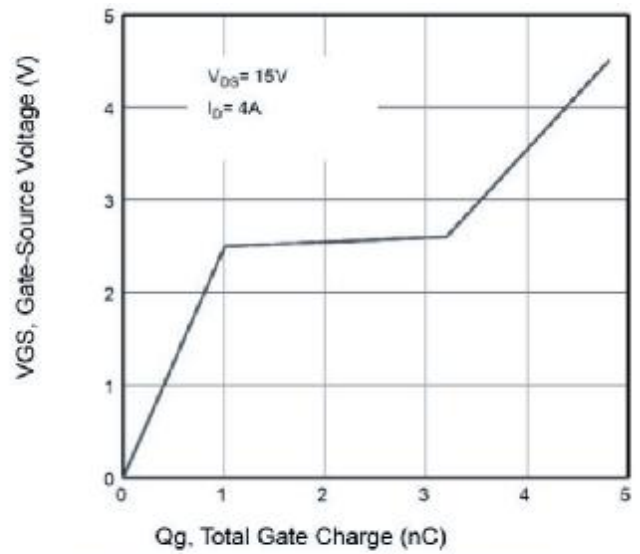

Fig8. Typical Gate Charge Vs. Gate-Source Voltage

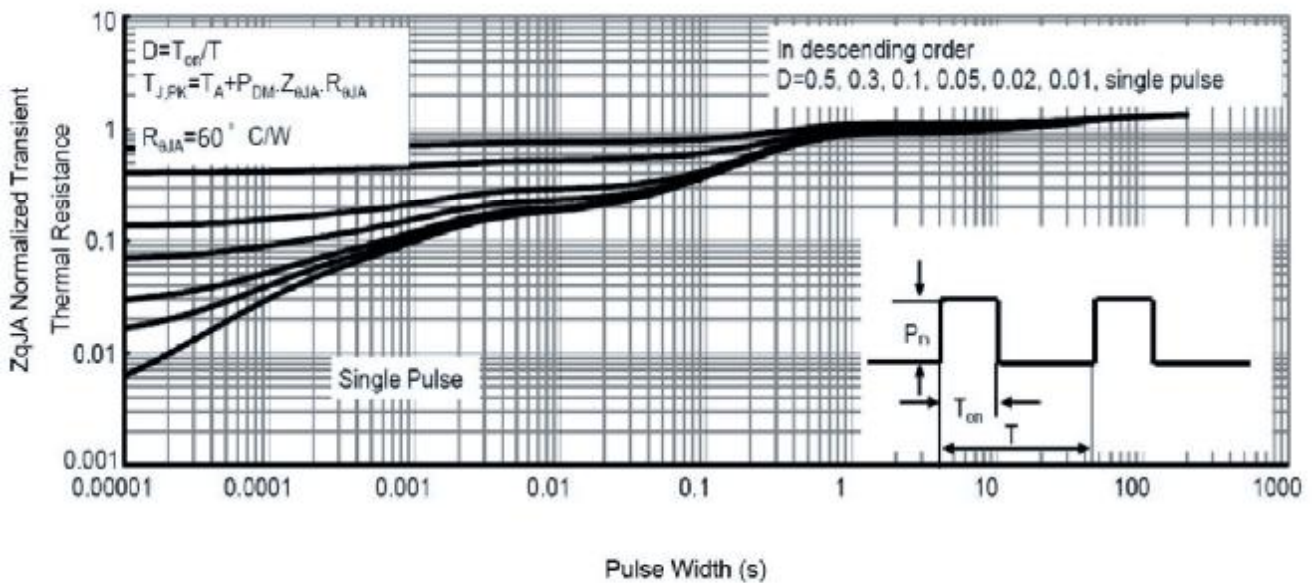

Fig9. Normalized Maximum Transient Thermal Impedance

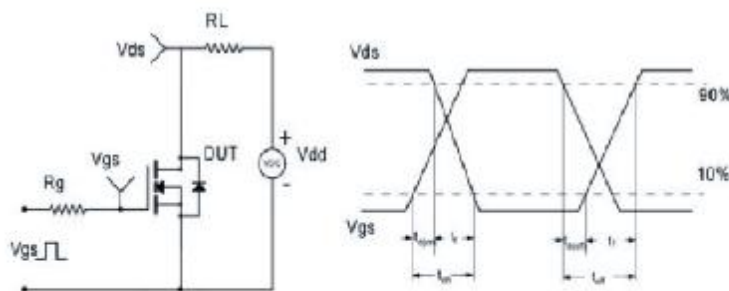

Fig10. Switching Time Test Circuit and waveforms