

## 1. Features

- n RoHS Compliant
- n  $R_{DS(ON),typ.}=0.75\Omega @ V_{GS}=10V$
- n Low Gate Charge Minimize Switching Loss
- n Fast Recovery Body Diode

## 2. Applications

- n Adaptor
- n Charger
- n SMPS Standby Power

## 3. Pin configuration

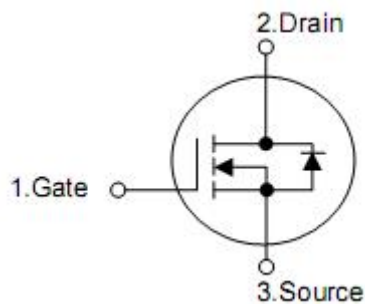
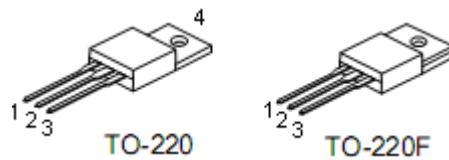

Pin	Function
1	Gate
2	Drain
3	Source
4	Drain

## 4. Ordering Information

Part Number	Package	Brand
KNP6165B	TO-220	KIA
KNF6165B	TO-220F	KIA

## 5. Absolute maximum ratings

TC=25°C unless otherwise specified

Parameter	Symbol	TO-220	TO-220F	Unit
Drain-to-Source Voltage	VDSS	650		V
Gate-to-Source Voltage	VGSS	±30		V
Continuous Drain Current	ID	10		A
Pulsed Drain Current at VGS=10V	IDM	40		A
Single Pulse Avalanche Energy	EAS	800		mJ
Power Dissipation	PD	125	45	W
Derating Factor above 25°C		1	0.36	W/°C
Soldering Temperature Distance of 1.6mm from case for 10 seconds	TL	300		°C
Operating and Storage Temperature Range	TJ& TSTG	-55 to 150		°C

## 6. Thermal characteristics

Parameter	Symbol	TO-220	TO-220F	Unit
Thermal Resistance, Junction-to-Case	R <sub>θJC</sub>	1.0	2.78	°C/W
Thermal Resistance, Junction-to-Ambient	R <sub>θJA</sub>	62	100	°C/W

## 7. Electrical characteristics

(T<sub>J</sub>=25°C, unless otherwise notes)

Parameter	Symbol	Conditions	Min	Typ	Max	Units
<b>OFF Characteristics</b>						
Drain-to-Source Breakdown Voltage	BV <sub>DSS</sub>	V <sub>GS</sub> =0V, I <sub>D</sub> =250uA	650	--	--	V
Drain-to-Source Leakage Current	I <sub>DSS</sub>	V <sub>DS</sub> =650V, V <sub>GS</sub> =0V	--	--	1	uA
		V <sub>DS</sub> =520V, V <sub>GS</sub> =0V, T <sub>J</sub> =125°C	--	--	100	uA
Gate-to-Source Leakage Current	I <sub>GSS</sub>	V <sub>GS</sub> =+30V, V <sub>DS</sub> =0V	--	--	100	nA
		V <sub>GS</sub> =-30V, V <sub>DS</sub> =0V	--	--	-100	nA
<b>ON Characteristics</b>						
Static Drain-to-Source On-Resistance	R <sub>DS(ON)</sub>	V <sub>GS</sub> =10V, I <sub>D</sub> =5.0A	--	0.75	0.9	Ω
Gate Threshold Voltage	V <sub>GS(TH)</sub>	V <sub>DS</sub> =V <sub>GS</sub> , I <sub>D</sub> =250uA	2	--	4	V
Forward Transconductance	g <sub>fs</sub>	V <sub>DS</sub> =15V, I <sub>D</sub> =5.0A	--	8.0	--	S
<b>Dynamic Characteristics(Essentially independent of operating temperature)</b>						
Input Capacitance	C <sub>iSS</sub>	V <sub>GS</sub> =0V, V <sub>DS</sub> =25V, f=1.0MHz	--	1650	--	pF
Output Capacitance	C <sub>oss</sub>		--	125	--	pF
Reverse Transfer Capacitance	C <sub>rss</sub>		--	13	--	pF
Total Gate Charge	Q <sub>g</sub>	V <sub>DD</sub> =520V, I <sub>D</sub> =10A, V <sub>GS</sub> =0 to 10V	--	30	--	nC
Gate-to-Source Charge	Q <sub>gs</sub>		--	8	--	nC
Gate-to-Drain (Miller) Charge	Q <sub>gd</sub>		--	8.5	--	nC
<b>Resistive Switching Characteristics(Essentially independent of operating temperature)</b>						
Turn-on Delay Time	t <sub>d(ON)</sub>	V <sub>DD</sub> =325V, I <sub>D</sub> =10A, V <sub>GS</sub> =10V R <sub>g</sub> =4.7Ω	--	10	--	nS
Rise Time	t <sub>rise</sub>		--	15	--	nS
Turn-Off Delay Time	t <sub>d(OFF)</sub>		--	41	--	nS
Fall Time	t <sub>fall</sub>		--	16	--	nS
<b>Source-Drain Body Diode Characteristics</b>						
Continuous Source Current <sup>[2]</sup>	I <sub>SD</sub>	Integral pn-diode in MOSFET	--	--	10	A
Pulsed Source Current <sup>[2]</sup>	I <sub>SM</sub>		--	--	40	A
Diode Forward Voltage	V <sub>SD</sub>	I <sub>S</sub> =10A, V <sub>GS</sub> =0V	--	--	1.5	V
Reverse Recovery Time	t <sub>rr</sub>	V <sub>GS</sub> =0V I <sub>F</sub> =I <sub>S</sub> , di/dt=100A/μs	--	455	--	ns
Reverse Recovery Charge	Q <sub>rr</sub>		--	1.5	--	nC

Note: 1.T<sub>J</sub>=+25°C to +150°C

2.Pulse width≤380μs; duty cycle≤2%.

8. Typical Characteristics

Figure 1. Maximum Transient Thermal Impedance

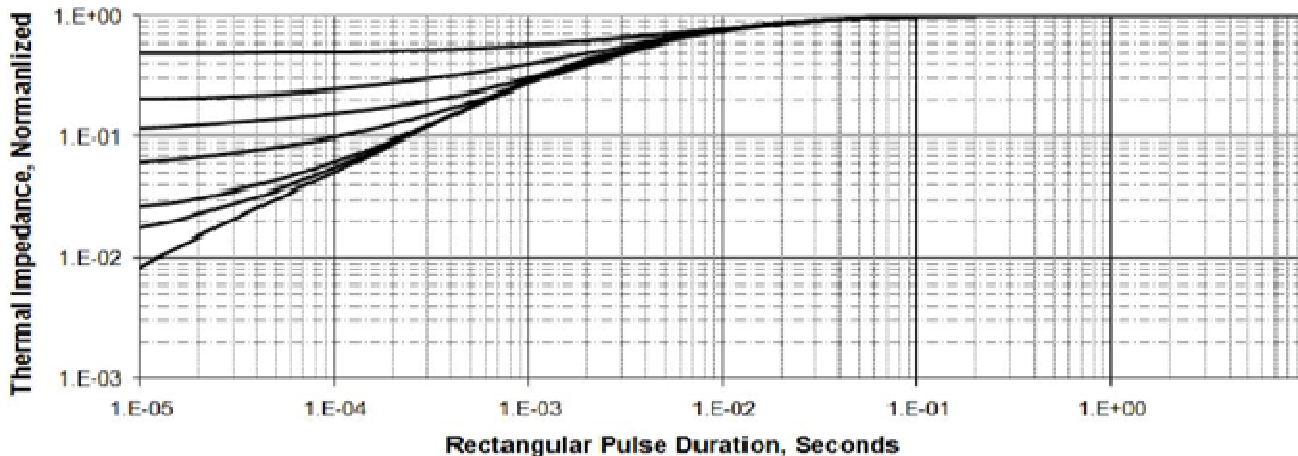

Figure 2. Max. Power Dissipation vs Case Temperature

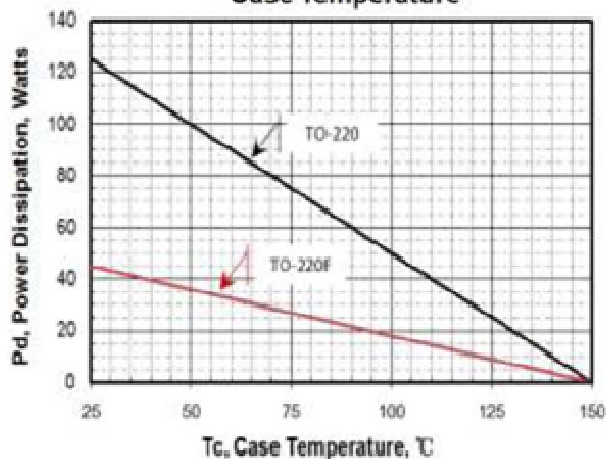

Figure 3. Maximum Continuous Drain Current vs Tc

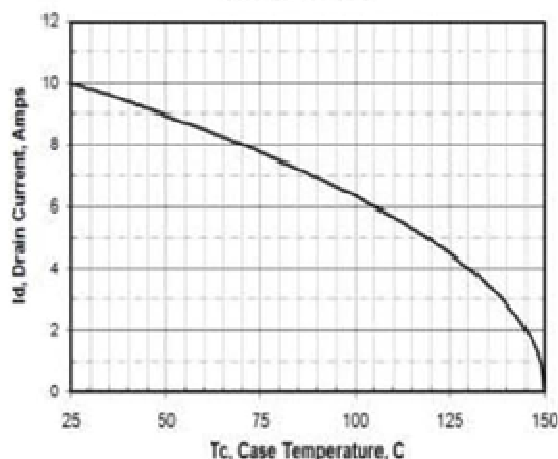

Figure 4. Output Characteristics

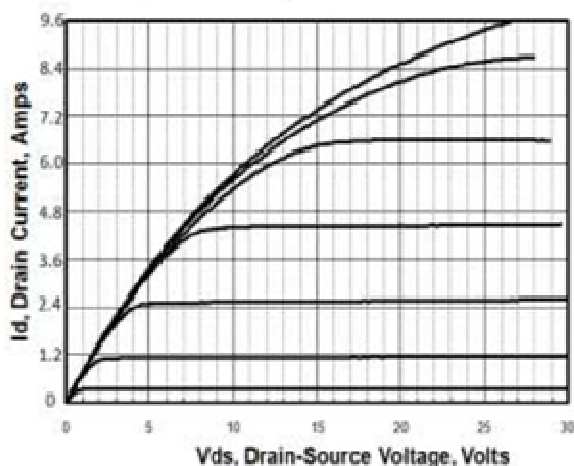

Figure 5. Rds(on) vs Gate Voltage

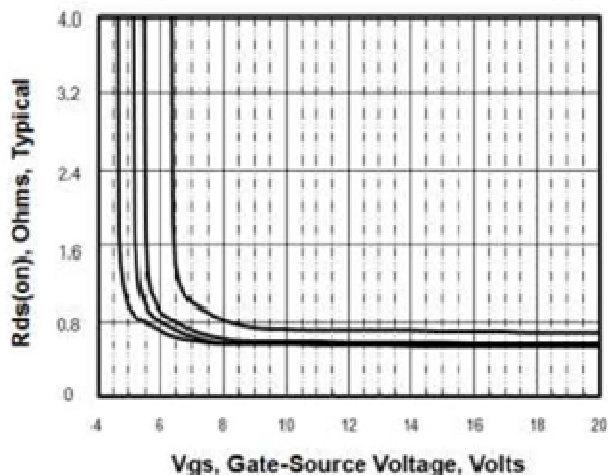

Figure 6. Peak Current Capability

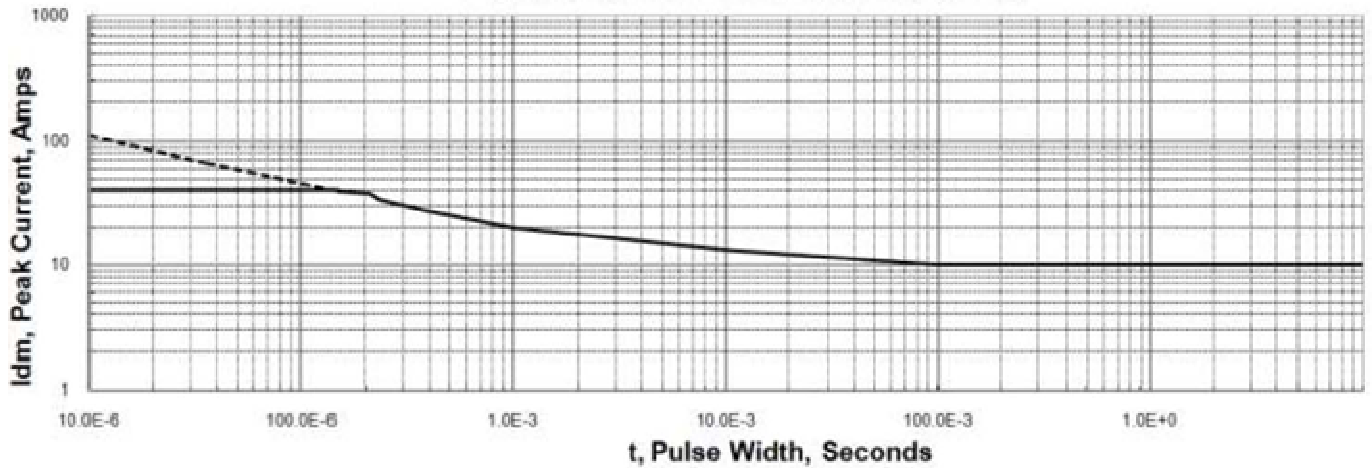

Figure 7. Transfer Characteristics

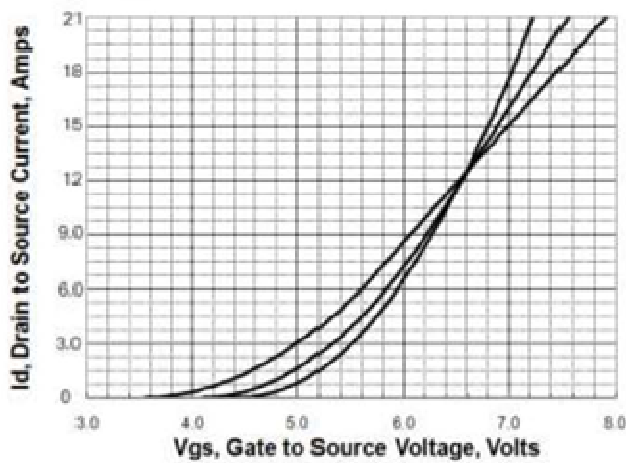

Figure 8. Unclamped Inductive Switching Capability

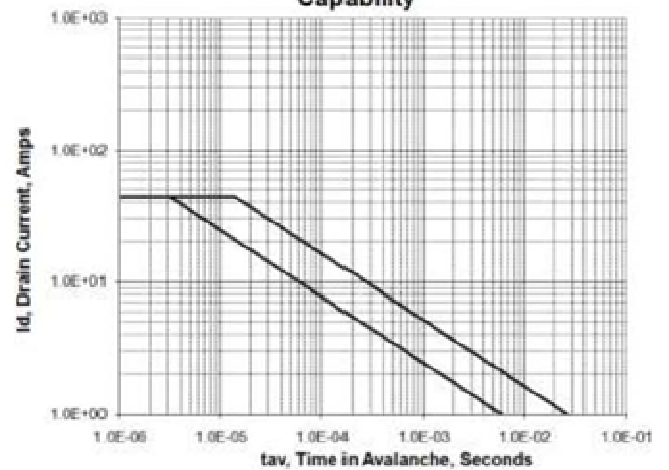

Figure 9. Drain to Source ON Resistance vs Drain Current

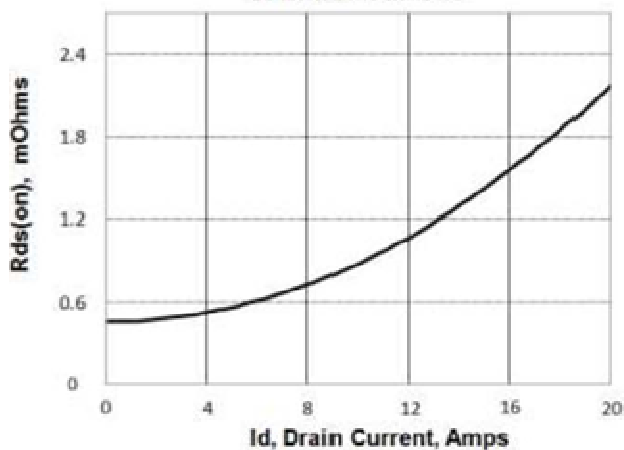
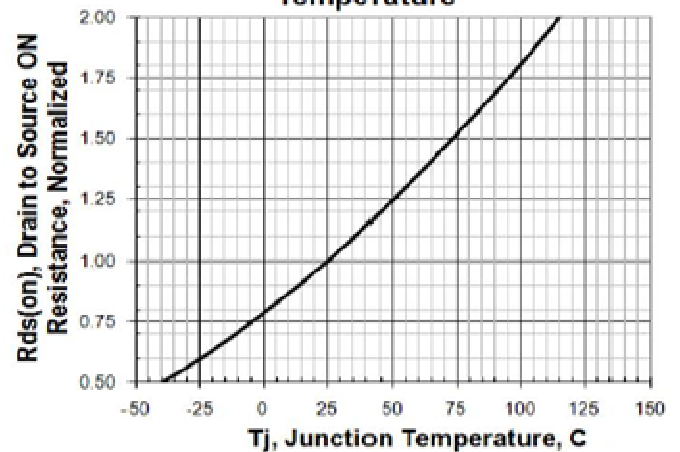
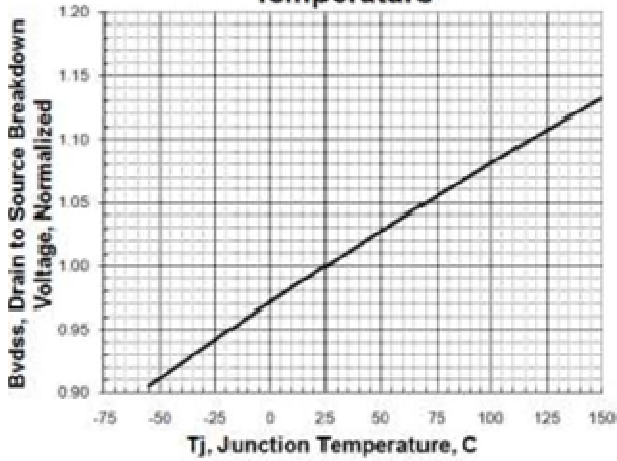

Figure 10. Rds(on) vs Junction Temperature



**Figure 11. Breakdown Voltage vs Temperature**



**Figure 12. Threshold Voltage vs Temperature**

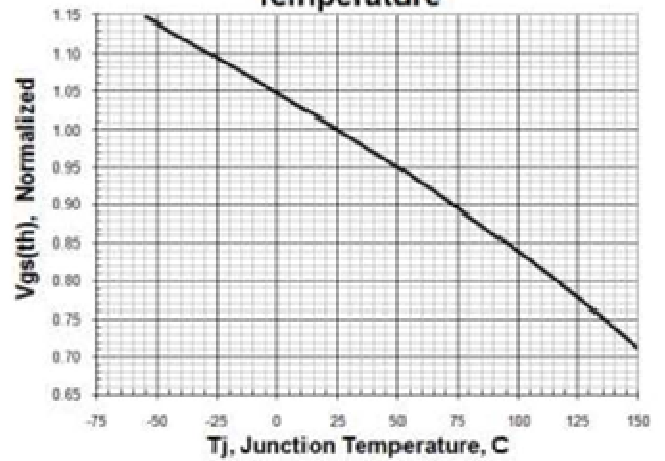

**Figure 13 . Maximum Safe Operating Area**

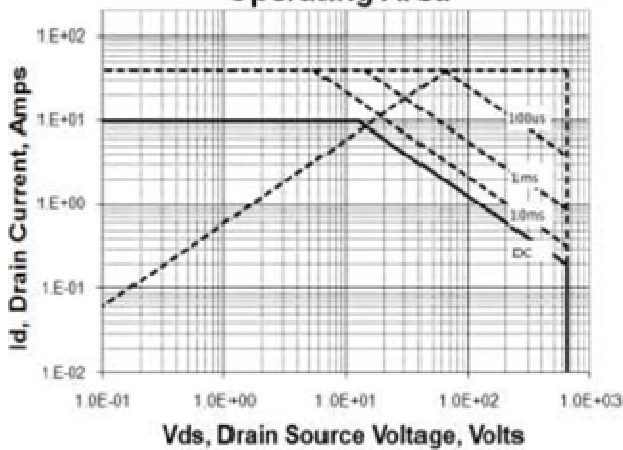

**Figure 14. Capacitance vs Vds**

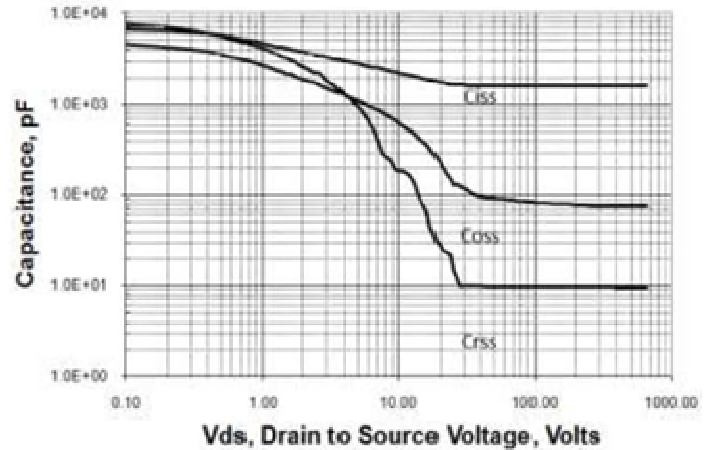

**Figure 15 . Typical Gate Charge**

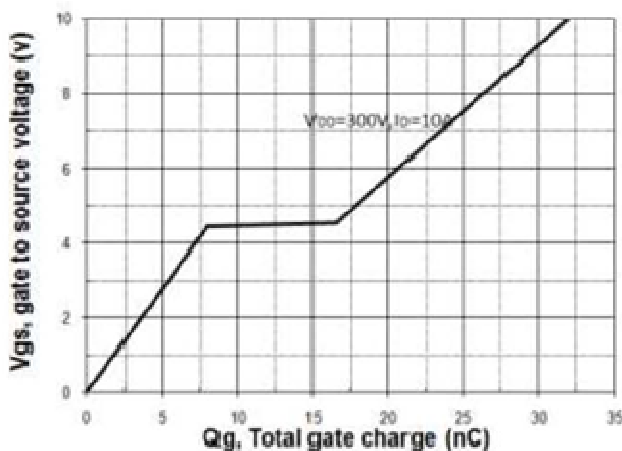

**Figure 16. Body Diode Transfer Characteristics**

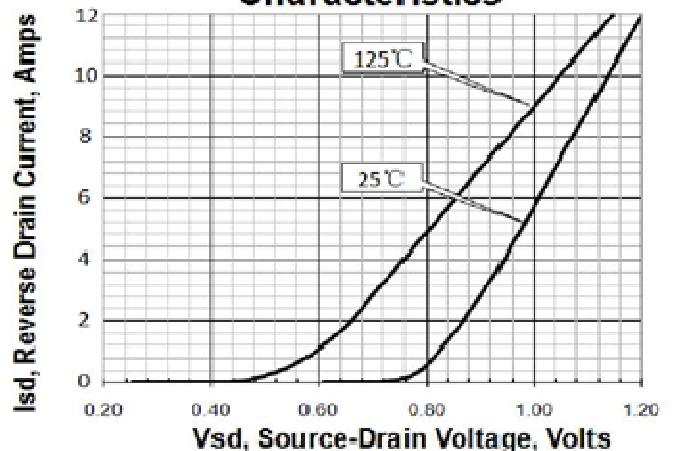

9. Test Circuits and Waveforms

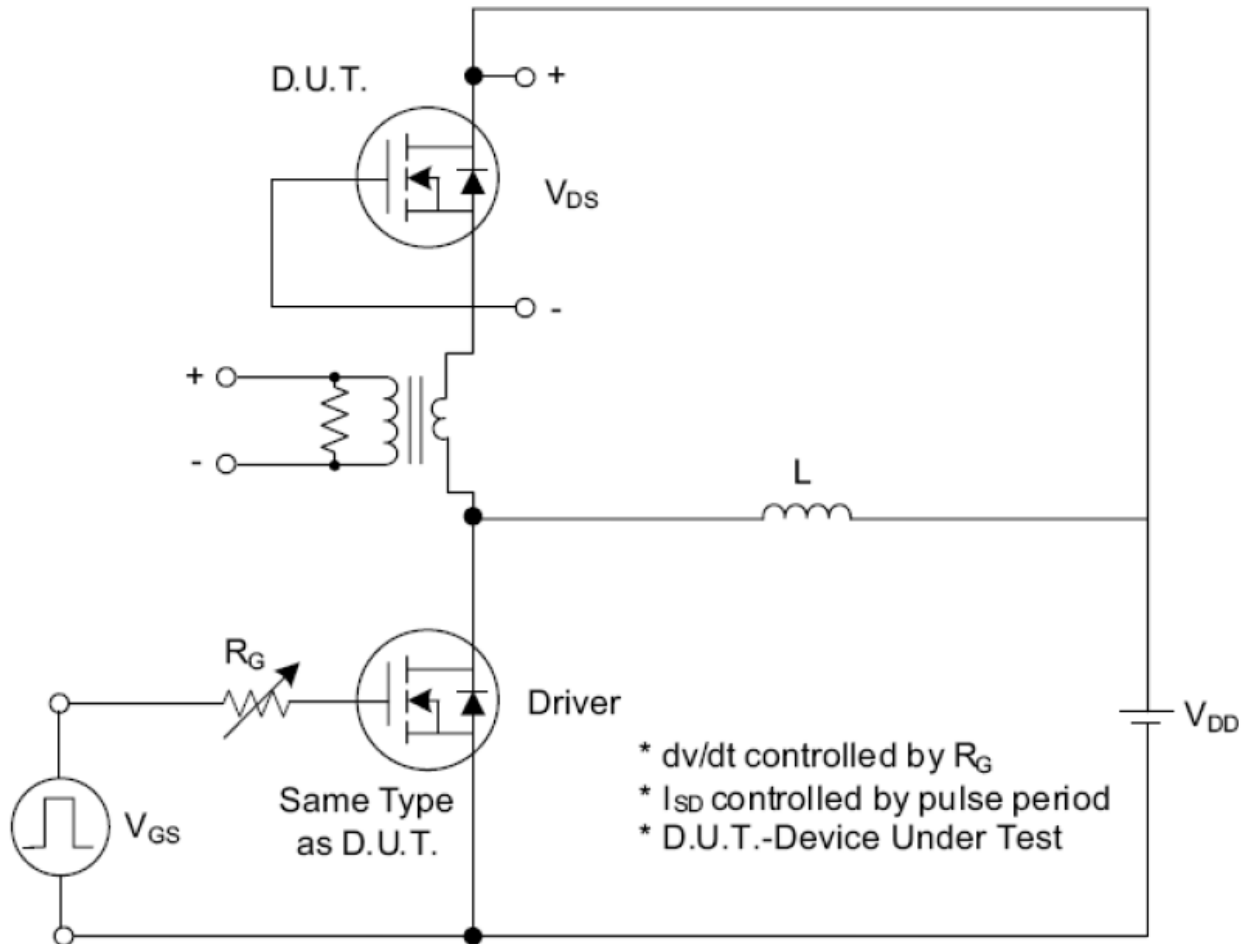

Fig. 1.1 Peak Diode Recovery  $dv/dt$  Test Circuit

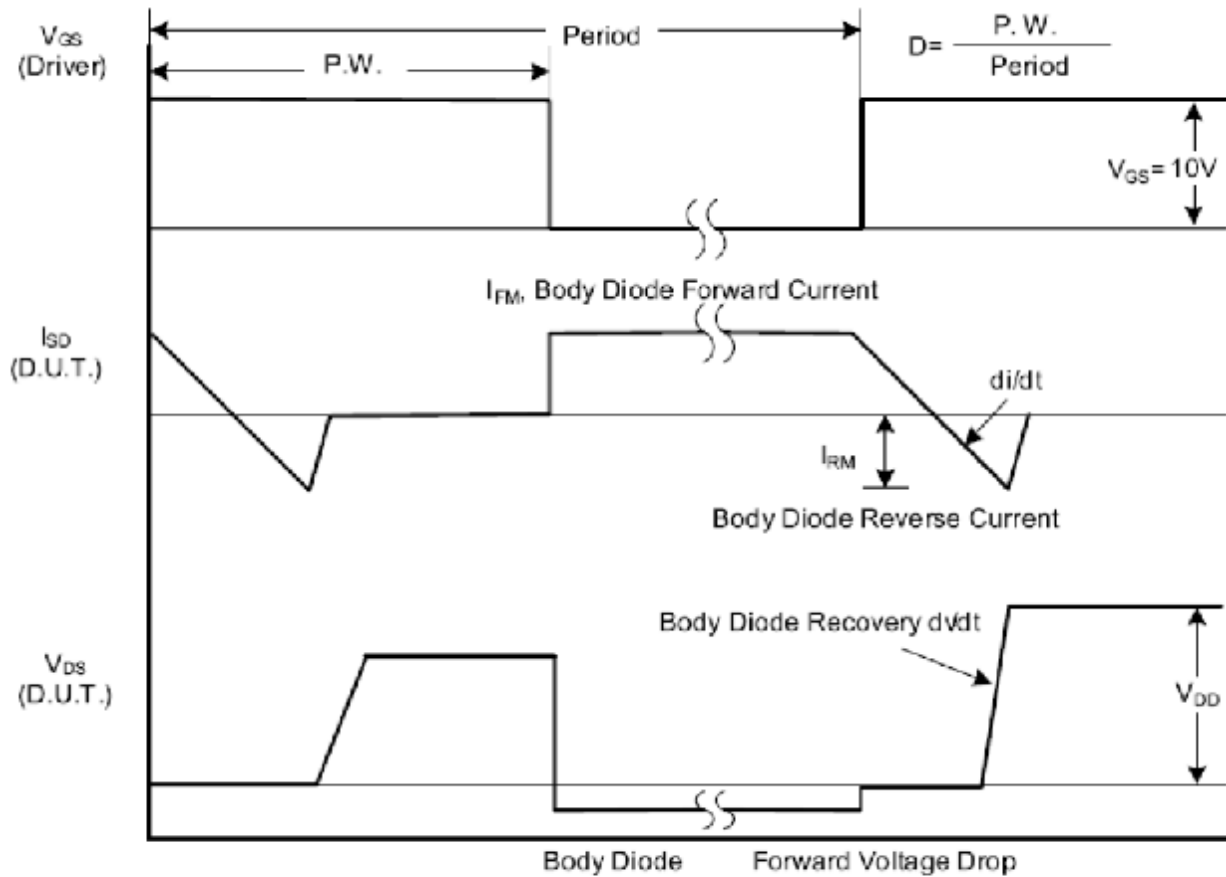

Fig. 1.2 Peak Diode Recovery  $dv/dt$  Waveforms

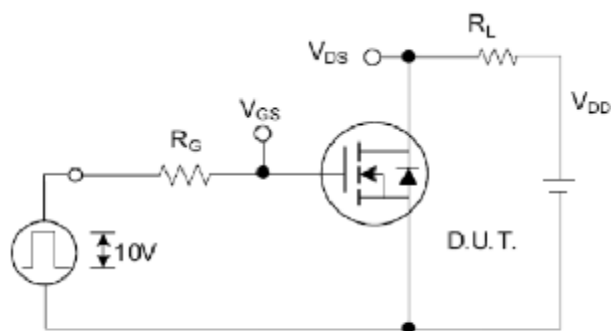

Fig. 2.1 Switching Test Circuit

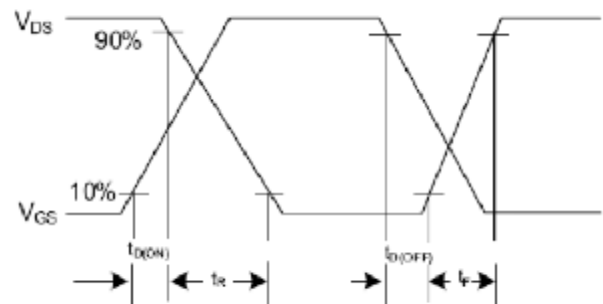

Fig. 2.2 Switching Waveforms



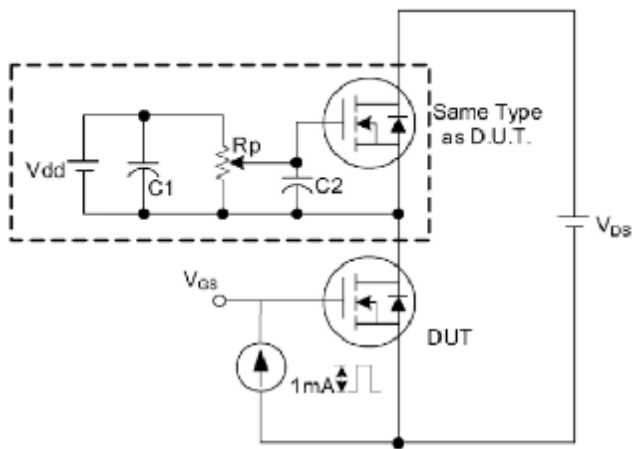

Fig. 3. 1 Gate Charge Test Circuit

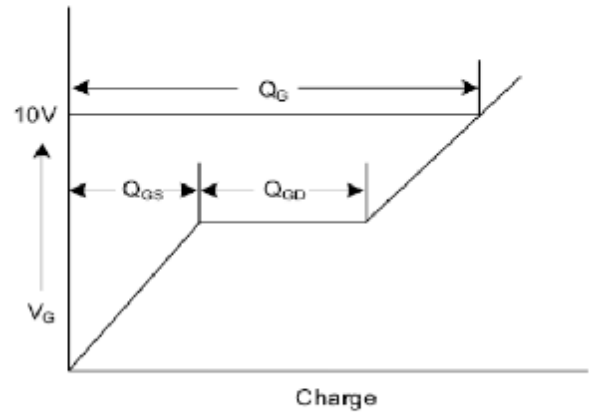

Fig. 3. 2 Gate Charge Waveform

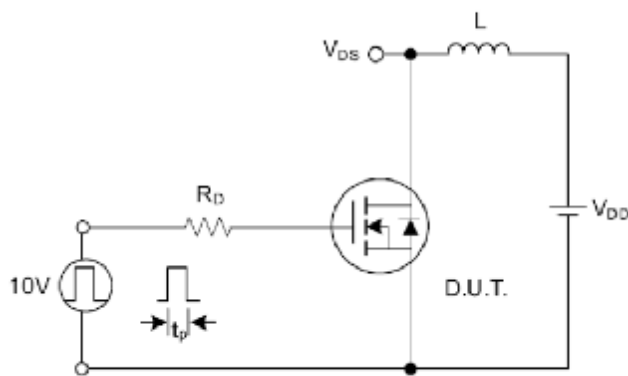

Fig. 4.1 Unclamped Inductive Switching Test Circuit

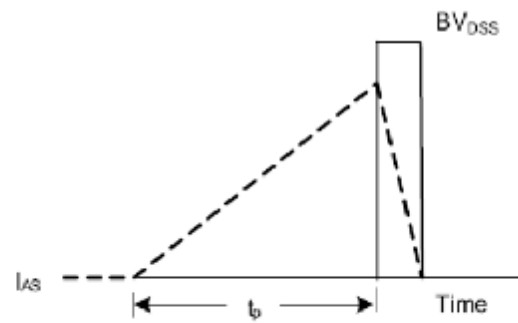

Fig. 4.2 Unclamped Inductive Switching Waveforms