

1. Description

The KIA30N06B is the highest performance trench N-ch MOSFETs with extreme high cell density, which provide excellent RDSON and gate charge for most of the synchronous buck converter applications. The KIA30N06B meet the RoHS and Green Product requirement, 100%EAS guaranteed with full function reliability approved.

2. Features

- n $R_{DS(on)}=25m\Omega @ V_{DS}=60V$
- n Advanced high cell density Trench technology
- n Super Low Gate Charge
- n Excellent Cdv/dt effect decline
- n 100%EAS Guaranteed
- n Green Device Available

3. Applications

- n High Frequency Point-of-Load Synchronous Buck Converter
- n Networking DC-DC Power System
- n Load Switch

4. Symbol

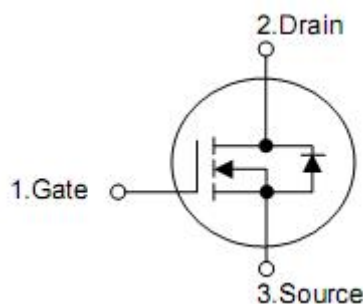
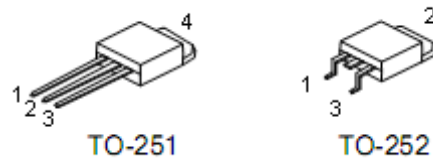

Pin	Function
1	Gate
2	Drain
3	Source
4	Drain

5. Absolute maximum ratings

Parameter	Symbol	Rating	Units
Drain-source voltage	V_{DS}	60	V
Gate-source voltage	V_{GS}	± 20	V
Continuous drain current, $V_{GS} @ 10V^1$	I_D	$T_C=25^\circ C$	A
		$T_C=100^\circ C$	A
Pulsed drain current ²	I_{DM}	50	A
Single pulse avalanche energy ³	E_{AS}	34.5	mJ
Avalanche current	I_{AS}	22.6	A
Total power dissipation ⁴	P_D	34.7	W
Operation junction temperature range	T_J	-55 to 150	$^\circ C$
Storage temperature range	T_{STG}	-55 to 150	$^\circ C$

6. Thermal characteristics

Parameter	Symbol	Typ	Max	Unit
Thermal resistance, Junction-ambient ¹	$R_{\theta JA}$	--	62	$^\circ C/W$
Thermal resistance, Junction-case ¹	$R_{\theta JC}$	--	3.6	

7. Electrical characteristics

(T_J=25°C, unless otherwise noted)

Parameter	Symbol	Test Conditions	Min	Typ	Max	Units
Drain-source breakdown voltage	BV _{DSS}	V _{GS} =0V, I _D =250μA	60	-	-	V
BV _{DSS} temperature coefficient	ΔBV _{DSS} /ΔT _J	Reference to 25 °C, I _D =1mA		0.063		V/°C
Static drain-source on-resistance ²	R _{DS(on)}	V _{GS} =10V, I _D =15A		25	30	mΩ
		V _{GS} =4.5V, I _D =10A		30	38	
Gate threshold voltage	V _{GS(th)}	V _{DS} =V _{GS} , I _D =250μA	1.2		2.5	V
V _{GS(th)} temperature coefficient	ΔV _{GS(th)}			-5.24		mV/°C
Drain-source leakage current	I _{DSS}	V _{DS} =48V, V _{GS} =0V T _J =25°C			1	μA
		V _{DS} =48V, V _{GS} =0V T _J =55°C			5	μA
Gate- source leakage current	I _{GSS}	V _{GS} =±20V, V _{DS} =0V			±100	nA
Forward transconductance	g _{fs}	V _{DS} =5V, I _D =15A		17		S
Gate resistance	R _g	V _{DS} =0V, V _{GS} =0V, f=1MHz		3.2		Ω
Total gate charge(4.5V)	Q _g	V _{DS} =48V, V _{GS} =4.5V I _D =10A	-	12.56		nC
Gate-source charge	Q _{gs}			3.24		
Gate-drain charge	Q _{gd}			6.31		
Turn-on delay time	t _{d(on)}	V _{DD} =30V, I _D =10A, R _G =3.3Ω, V _{GS} =10V		8		ns
Rise time	t _r			14.2		
Turn-off delay time	t _{d(off)}			24.4		
Fall time	t _f			4.6		
Input capacitance	C _{iss}	V _{DS} =25V, V _{GS} =0V, f=1MHz		1345		pF
Output capacitance	C _{oss}			72.5		
Reverse transfer capacitance	C _{rss}			54.4		
Single pulse avalanche energy ⁵	EAS	V _{DD} =25V, L=0.1mH, I _{AS} =15A	15.2			mJ
Continuous source current ^{1,6}	I _S	V _G = V _D =0V, Force current			25	A
Pulsed source current ^{2,6}	I _{SM}				50	A
Diode forward voltage ²	V _{SD}	V _{GS} =0V, I _S =1A, T _J =25°C			1.2	V

Note:1.The data tested by surface mounted on a 1 inch² FR-4 board with 20Z copper.

2.The data tested by pulsed, pulse width≤300μs,duty cycle≤2%

3.The EAS data shows Max.rating.The test condition is V_{DD}=25V, V_{GS}=10V,L=0.1mH,I_{AS}=15A

4.The power dissipation is limited by 150°C junction temperature

5.The Min, value is 100% EAS tested guarantee.

6.The data is theoretically the same as I_D and I_{DM},in real applications, should be limited by total power dissipation.

8. Test circuits and waveforms

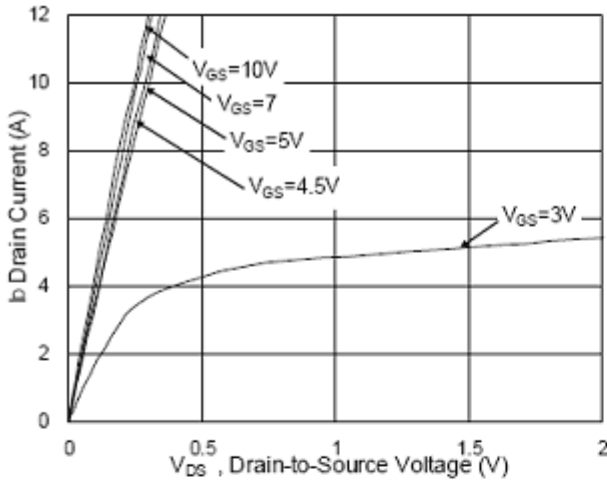

Fig.1 Typical Output Characteristics

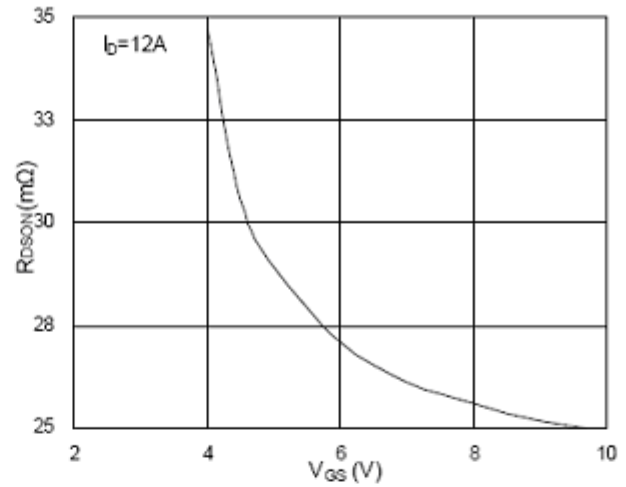

Fig.2 On-Resistance v.s. Gate-Source

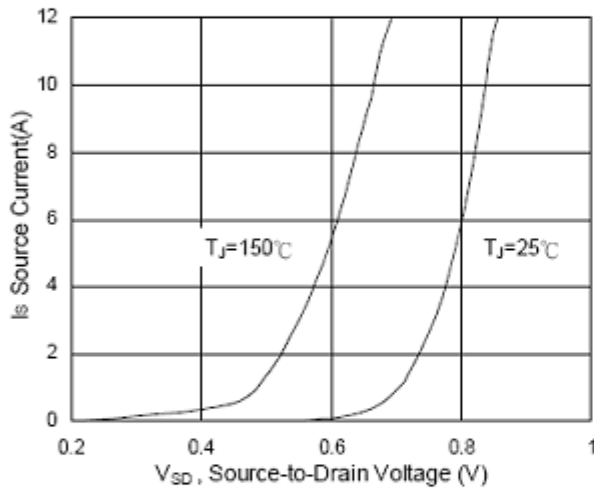

Fig.3 Forward Characteristics of Reverse

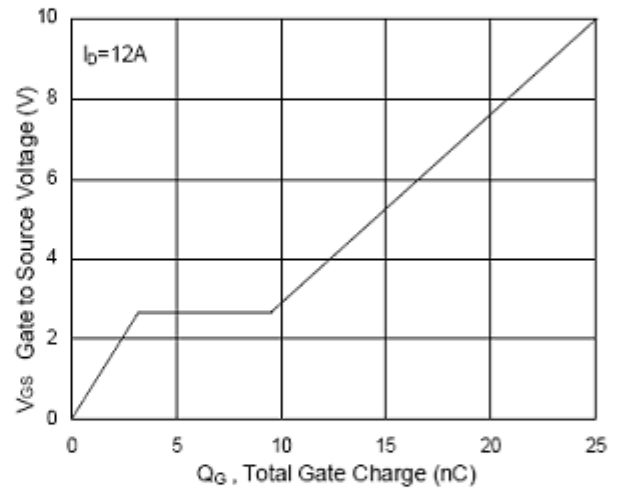

Fig.4 Gate-Charge characteristics

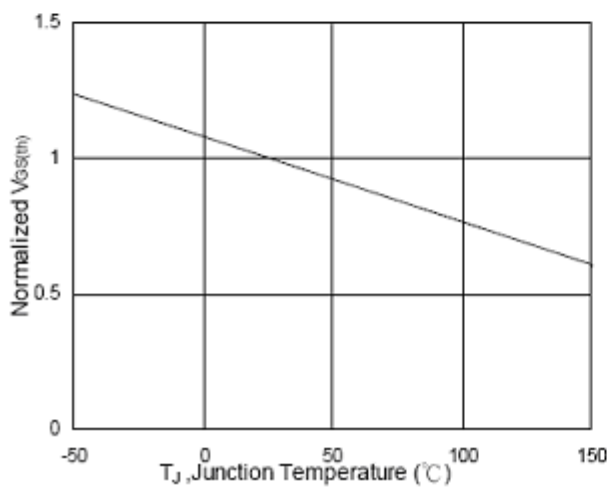

Fig.5 Normalized $V_{GS(th)}$ v.s T_J

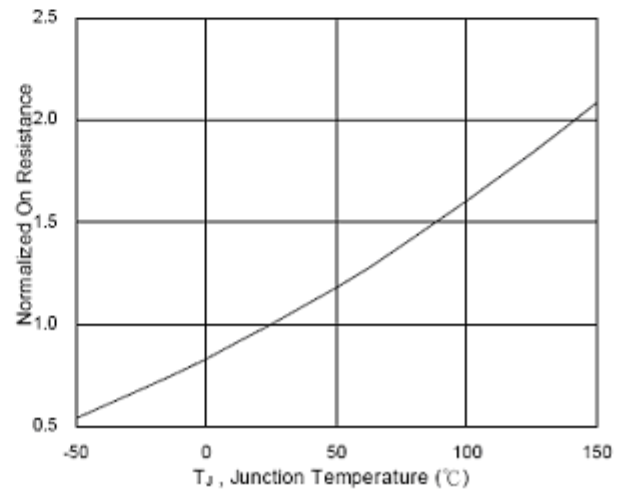

Fig.6 Normalized $R_{DS(on)}$ v.s T_J

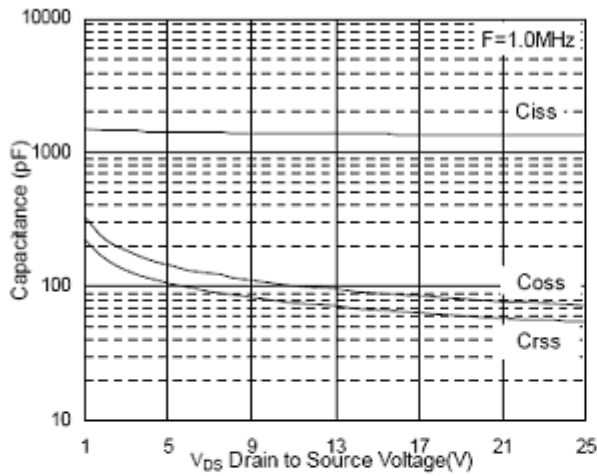

Fig.7 Capacitance

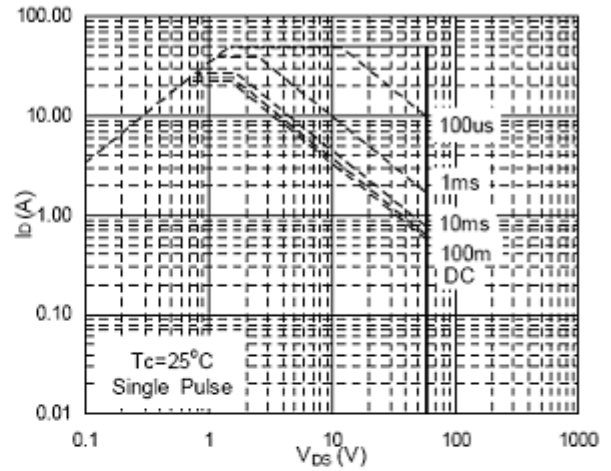

Fig.8 Safe Operating Area

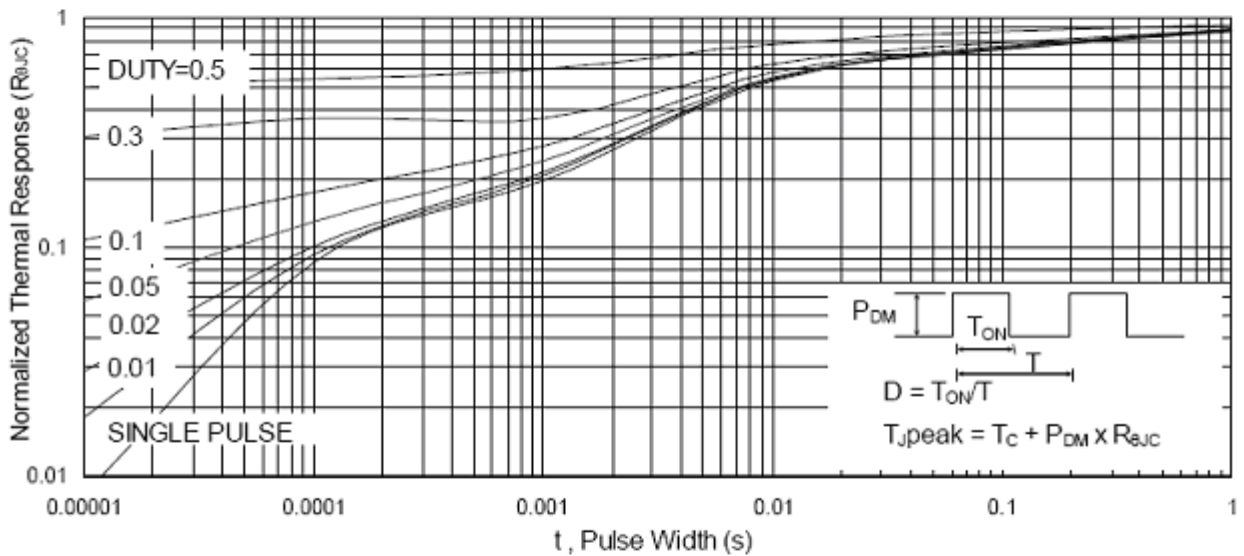

Fig.9 Normalized Maximum Transient Thermal Impedance

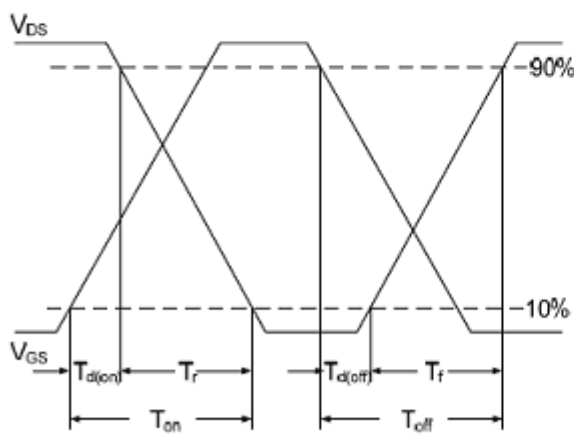

Fig.10 Switching Time Waveform

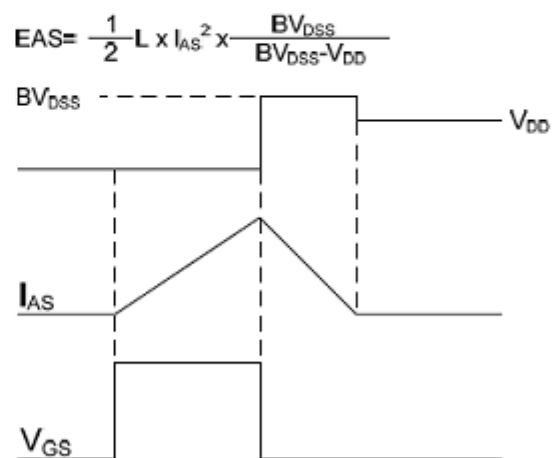

Fig.11 Unclamped Inductive Waveform